

markilux® - Awnings

Important Information for the users of markilux® Awnings

1. Fabrication number

Every markilux® awning has been manufactured individually according to your specifications and bears a fabrication number, which makes this product uniquely identifiable at all times.

2. Important safety symbols

 Notices which refer to dangers, which could lead to serious injuries or even death, are identified with this warning triangle. Apart from this, it indicates important functional information for the awning!

 Notices which refer to dangers from electrical shock, which could lead to serious injuries or even death, are identified with this warning triangle.

3. Reading the "Important Information", "Usage in Wind, Rain and Snow" and the "Operating Instructions"



 The instructions handed over by the markilux® specialist retailer must be read through before the initial use of the awning. For the safety of persons, it is important to follow all instructions.

All instructions are to be kept safely by customers and must be handed over to the new owner with a possible transfer of the awning to a third party.

4. Proper intended use of an awning

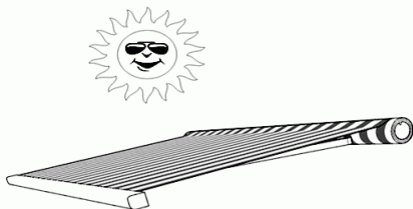

 The awning is a sun protection system. Through incorrect usage, considerable dangers can occur.

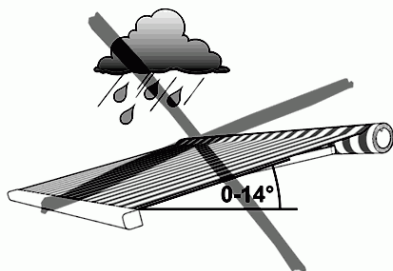

 If the pitch angle of the awning is less than **25% = 14°**, measured from the horizontal **and** the awning is **not completely extended**, then this must not be loaded through rain. There exists the danger of pockets of water forming in the awning cover, through which the awning could be damaged or collapse.

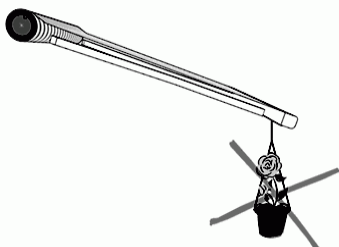

 Modifications, such as add-ons and conversions not intended by the manufacturer, may only be performed with the written consent of the markilux® manufacturer. Additional loading of the awning due to suspended objects or due to tensioned ropes/cables can lead to damage or to the collapse of the awning and are therefore not permitted.

5. Wind Resistance Class



markilux®

Schmitz-Werke GmbH Co. KG
Hansestraße 87
D-48282 Emsdetten

DIN EN 13561

Markise für die Verwendung im Außenbereich

Windwiderstandsklasse 2

The awning fulfills the requirements of the wind resistance class specified in the CE mark of conformity (explanation see **"Usage in Wind, Rain and Snow"**).

The CE mark of conformity states, that a conformity with the requirements of the applicable European directives has been proven, the corresponding explanations can be requested via the markilux® specialist retailer.

6. Use in Snow, Ice, Lightning, Storm and Absence also with Automatic Controller

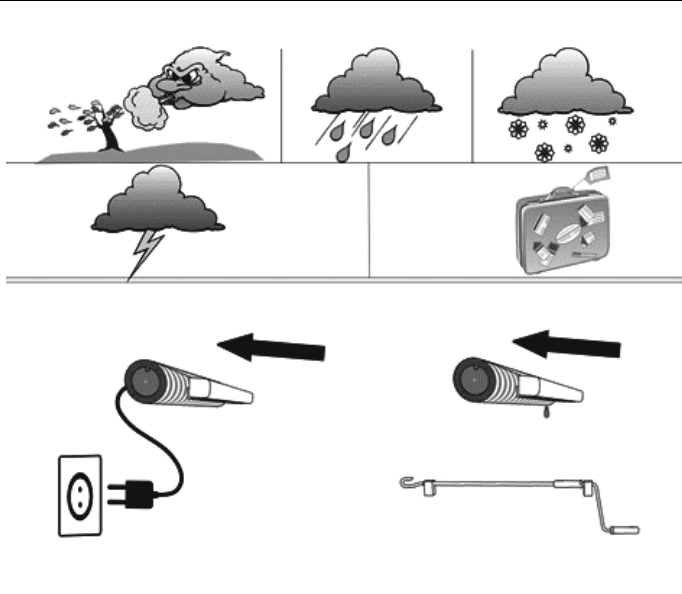

The awning may not be extended during snowfall or the danger of frost. The danger exists that the awning could be damaged or collapse.

With lightning or bad weather fronts approaching, sudden strong gusts can occur, to which even a controller cannot react immediately.

An automatic controller expands the comfort of the awning, but does not release from the duty of care!

With longer absence, e.g. vacation or overnight stays, an automatic controller is no guarantee for continuous perfect functioning of your awning.

⚠ It is recommended to retract the awning in time before the occurrence of freezing moisture, with lightning or bad weather fronts approaching or during absence. Any possible existing automatic control is to be switched off!

7. Leaves and foreign matter

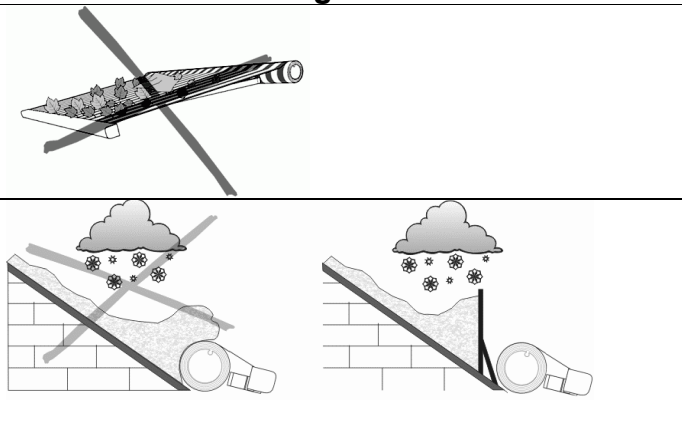

Leaves and other foreign matter lying on the awning cover, in the awning box and in the track profiles are to be removed immediately. The danger exists that the awning could be damaged or collapse.

An accumulation of snow behind the awning is to be prevented by fitting a snow guard (snow fence or similar) or regular removal of the snow load.

8. Obstructions

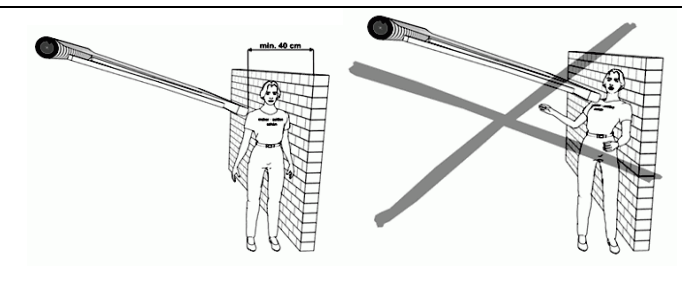

There must be no obstructions in the extending range of the awning. The danger exists of people being crushed there.

9. Motor with emergency operation during power failure

A motor-driven awning cannot be retracted without power. In windy regions with frequent power failures, the use of an emergency hand operation device or an emergency power supply should be considered.

The control part of the emergency manual operation must be accessible at a height of less than 1.8 meters. Otherwise always retract the awning beforehand, if the power supply will be interrupted!

10. Uncontrolled operation during cleaning and maintenance work

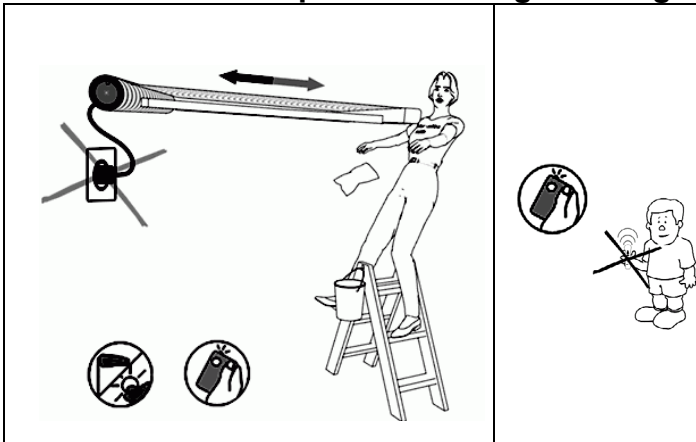

⚠ When working in the range of travel (e.g. cleaning and maintenance work), it is to be ensured, that the awning is switched de-energized (e.g. switch off safety device, disconnect plug coupling on the motor cable, ...) There is a risk of being crushed and falling down. Likewise, with manual operation the operating crank must be disengaged and safely stored away.

If awnings are operated by several users, a priority switching interlocking device (controlled power interruption from outside) must be actuated, which makes any extending and retracting of the awning impossible. Persons not familiar with the proper use of the awning must not operate it.

11. Repair and spare parts

The awning is to be inspected regularly for signs of wear or damage to cover and frame (with electrical connection: also to the power cables). If damage is determined, then a markilux® specialist retailer is to be commissioned with the repair. Only spare parts released by the manufacturer may be used.

⚠ Attention! Danger of Injury! Never attempt to repair the fault yourself! Awnings in need of repair must not be used.

Talk to your markilux® specialist retailer about a service contract!

12. 10. Crush and Shear Zones

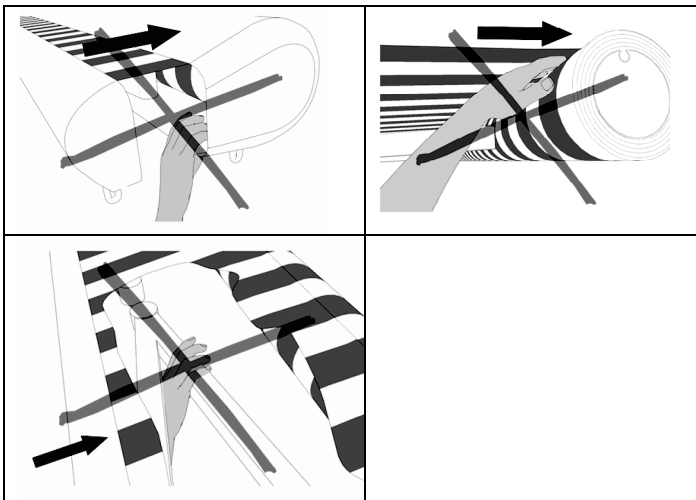

⚠ Depending on the type of awning, there exist crush and shear zones, e.g. between drop rod and cassette and between moving parts. Items of clothing or limbs can be grabbed by the unit and pulled in! If an awning is fitted at a height under 2.5 meters above accessible traffic routes, then the awning may only be actuated with a push-button switch with a view of the moving parts. Electrical controllers, radio-controlled drives with catch switches, stop switches etc. are in this case not permitted.

13. Disassembly and disposal

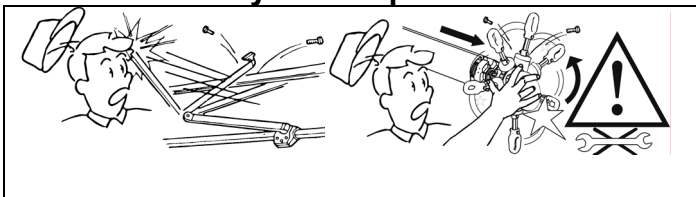

⚠ Attention! Danger of Injury! During disassembly and disposal of the shading unit, those parts under tension (e.g. folding arms, tensioning systems) must be relieved completely beforehand or secured against unintentional extending. A markilux® specialist firm is to be commissioned for this!

14. Maintenance and care

<p>Whether or not cleaning is necessary greatly depends on the environmental influences (traffic, air pollution, industrial gases etc.). Depending on the degree of soiling, regular cleaning is recommended.</p> <p>⚠ Attention: Always use a suitable climbing aid and never support yourself on the awning or hold on to it!</p>	<p>Remove dust with a soft brush periodically when dry. Remove foliage and similar dirt immediately. Treat small stains on the awning cover with a common, preferably liquid fine detergent mixed with water (water temperature approx. 30°C, soap solution 5 %). Rinse thoroughly with water until all detergent residues have been removed.</p>
14.1 Awning cover when wet	<p>If possible, only retract awning when dry! If the awning must be retracted wet, this must be extended again to dry as soon as possible. Due to the cover's own weight a sagging is possible, which increases when wet. With wide units, a sagging of the awning frame profile can also occur due to its own weight. Both facts do not impair the function and running characteristic of the awning.</p>
14.2 Cleaning the awning cover	<p>The awning cover is furnished with special waterproofing, which diminishes with each cleaning. For re-waterproofing, common tent waterproofing can be used. A new condition of the material can not however be achieved through re-waterproofing.</p>
14.3 Cleaning the awning frame	<p>For the cleaning of the awning frame, use common household cleaner for sensitive surfaces (pH-value: between 5 and 8). Aggressive acids and scratching materials (such as fabrics containing abrasives, sand paper, sand, pumice stone etc.) are not permitted, as they could greatly change the surface.</p>
14.4 Characteristics due to production and ready fabrication of awning materials	<p>Despite all due care in production and fabrication, technical fabrics can have characteristics, which to the layman represent „defects“. Defects worthy of complaint are only those, which impair the serviceable life of the cover.</p> <p>The blemishes described below in no way impair the durability and the performance capability of the awning cover.</p> <ul style="list-style-type: none">• <i>Wrinkle folds:</i> During processing, such as e.g. cutting to size, stitching and pulling the cover onto the awning frame, traces of folding can occur, which are unavoidable. Viewed against the light, the user of the awning has the impression that it concerns stripes of dirt, which is not however the case.• <i>Winding folds/rippling:</i> This occurs due to the permanent coiling and uncoiling of the cover on the roller. This effect can be explained by the fact, that the material is thicker close to the seams, coils more loosely between the seams of the cover. This effect can occur both directly next to the seam as well as also in the middle of web.• <i>Other irregularities:</i> Unavoidable minor blemishes caused due to the manufacturing process, such as knots and thread thickening, which are perceived in the cover as points of light or knobs, can occur and are not legitimate complaints.
14.5 Sagging of the awning frame	<p>With wide units, a sagging of the awning frame profile can also occur due to its own weight. This fact does not impair the function and running characteristics of the awning.</p>

15. Awning cover tested for harmful substances



Test sostanze nocive

Schadstoffgeprüfte Textilien

Tested for harmful substances

Getest op schadelijke stoffen

Contrôle de substances indésirables

secondo / nach / according to /
volgens / d'après

Öko-Tex Standard 100

ACB-Prüf-Nr. A96-0071 · FI Hohenstein

The "**Eco-Tex Standard 100**" certificate guarantees, that the awning cover does not contain any harmful dyestuffs or chemicals.

markilux® -1500/1600

Operating Instructions

To be passed on to the users of folding-arm awnings

1.1 Overview markilux® -1500

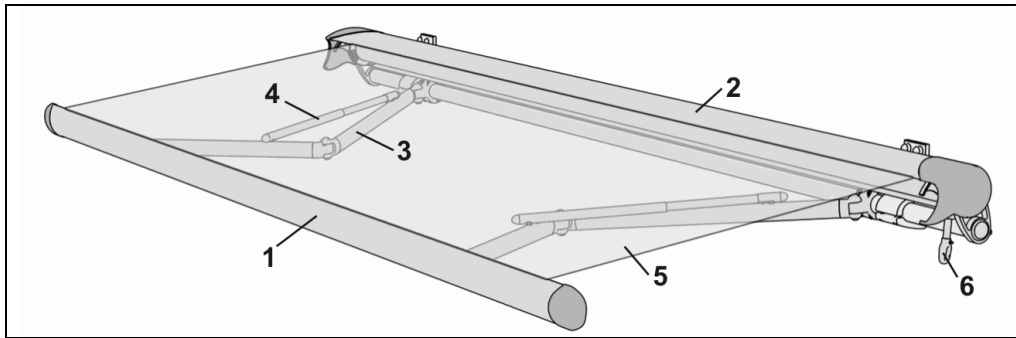

- 1 FRONT PROFILE
- 2 COVERBOARD
- 3 FOLDING ARM
- 4 GAS PRESSURE SPRING
- 5 COVER
- 6 TRANSMISSION EYELET

1.2 Overview markilux® -1600

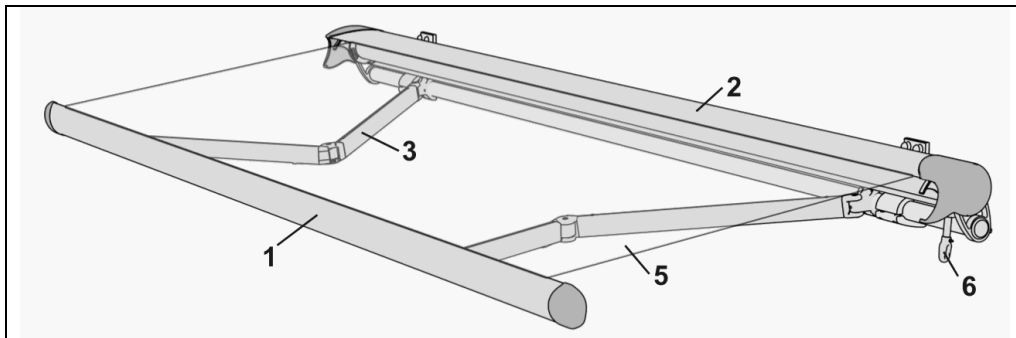

2. Reading the instructions

⚠ Attention: Before operating your awning, read all points specified under "Usage in Wind, Rain and Snow" and "Important Information"!

3. Awning with hand crank operation

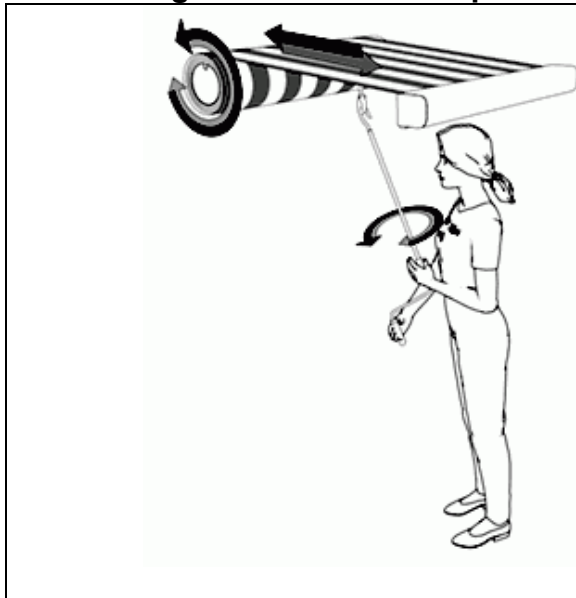

3.1 Engage the hook of the crank rod in the transmission eyelet.



3.2 Hold the crank rod firmly with one hand on the upper and one hand on the lower turning handle. During the operating procedure, pull the crank slightly towards the operator.

3.3 If the transmission eyelet is on the **right side** (as illustrated):

- Extending the awning cover: turn the crank anti-clockwise.
- Retracting the awning cover: turn the crank clockwise.

If the transmission eyelet is at the **left side**, the directions of rotation are precisely the opposite.

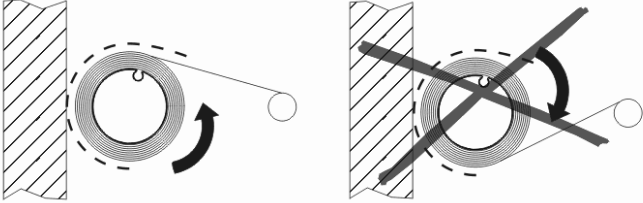
⚠ Attention: In partly extended position and with flat pitch angles (less than 14°), there is an increased risk of water collecting on the surface of the cover. The optimal cover tension is with the awning extended.

	<p>3.4  Attention: Awnings with winding handle have a transmission end stop to limit the extension travel. It prevents incorrect coiling of the cover onto the roller. The transmission end stop must never be approached with force. Shortly before reaching the end position in the extending direction, the crank operation should be slowed in a controlled manner in order to avoid a forced overtravel of the transmission brake.</p> <p>If the transmission end stop is defective, a coiling of the cover from below onto the roller during retracting can lead to damage to the awning cover and the awning frame.</p> <p>3.5 If the crank rod is to be left in the transmission eyelet, it must be secured against uncontrolled movements (e.g. during wind)!</p>
---	--

4. Awning with motor drive

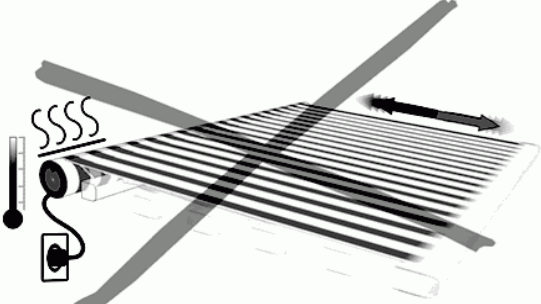
<p>4.1 Extend the awning by pressing the push-button switch for extending/retracting. With radio-controlled operation, your markilux®-specialist must exactly explain the functions on the radio remote control to you, since, depending on the equipment, he can set these for you individually.</p> <p>Thereby observe the separate operating instructions of the motor and, if available, the controller manufacturer.</p>	<p>The end stop for extending/retracting the awning is limited.</p> <p>If the cover is not taut when the unit is extended, then the motor end positions are to be readjusted by your markilux® specialist.</p> <p> Attention: In partly extended position and with flat pitch angles (less than 14°), there is an increased risk of water collecting on the surface of the cover. The optimal cover tension is with the awning extended.</p>
	<p>4.2 Extending and retracting the awning several times in quick succession causes the automatic shutdown of the motor, which is thereby protected from overheating. After cooling down, the motor automatically switches back to standby.</p>

5. Awning with Shadeplus

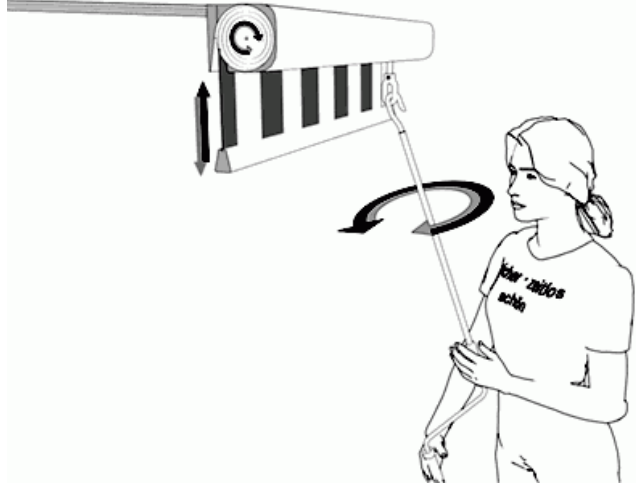
	<p>5.1 Operating Shadeplus with hand crank drive</p> <p>5.1.1 Extend/Retract the cover in the front profile: insert the hook of the crank rod into the transmission eyelet.</p> <p>5.1.2 Hold the crank rod firmly with one hand on the upper and the other hand on the lower turning handle. During the operating procedure, pull the crank slightly towards the operator.</p> <p>If the transmission is at the <u>right side</u> of the front profile: turning the crank rod anti-clockwise the Shadeplus extends, turning it clockwise, Shadeplus retracts.</p> <p>If the transmission is at the <u>left side</u> of the front profile (as illustrated): turning the crank rod clockwise the Shadeplus extends, turning it anti-clockwise, the Shadeplus retracts.</p> <p>5.1.3 After retracting or extending, remove the crank rod from the transmission eyelet and put it away in a safe place.</p> <p>If the crank rod is to be left in the transmission eyelet, it must be secured against uncontrolled movements (e.g. during wind).</p>
---	--

		<p>5.1.4 Rotating direction when retracting Shadeplus: If the coiling direction is incorrect, then the valance will not close flush to the front profile.</p> <p>Tip: If the valance profile does not retract mating positively into the front profile, extend Shadeplus cover completely and retract with uniform crank turning motion. Afterwards, when extending and retracting, operate the winding crank in the opposite rotating direction again.</p>
		<p>5.2 Operating Shadeplus with motor drive For this observe the instructions specified under 3. Attention: The motor for the Shadeplus cover cannot be equipped with an automatic controller.</p>
<p>1.</p>	<p>2.</p>	<p>5.3 Important Information!</p> <p>⚠ Attention: Always retract the Shadeplus cover first, before the entire awning is retracted. If the main motor of the awning is equipped with a controller, then never leave your extended Shadeplus cover unattended, as the awning could retract unintentionally!</p> <p>Take special care during wind, that the Shadeplus awning cover does not make any uncontrolled movements with its flounce profile. With the wind approaching, retract your Shadeplus cover immediately.</p>

6. Converting or retrofitting:

The following optional conversions can be subsequently carried out on your awning by your markilux® specialist:

- Change the awning cover
- Install a motor
- Retrofit with automatic controllers. Basically, for that a motor drive must be available. Ask your specialist retailer about sun and wind sensors, remote control etc.

7. What you should also know:

From an awning cover projection of 3.5 m, in the retraction and extension phase the cover may rest on the folding arms, however when fully extended it is tensioned again. This fact does not impair the function and running characteristic of the awning.

8. Safety Information:

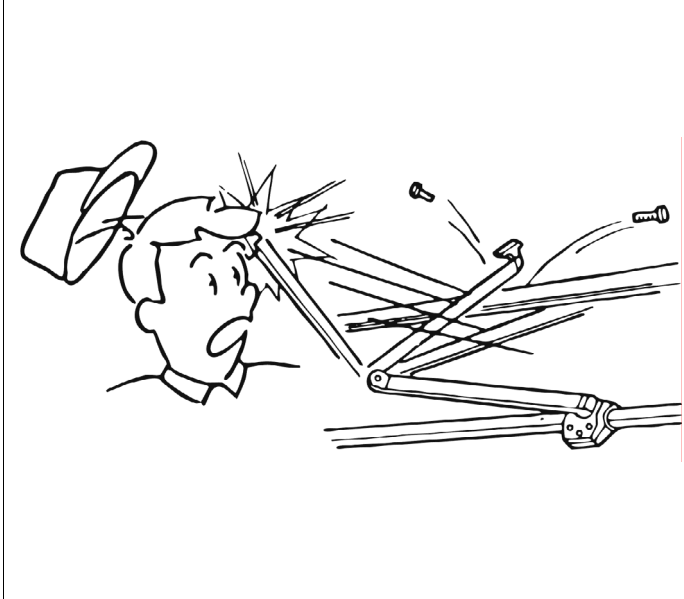

⚠ Attention! Danger of Injury!

The folding arms of the markilux®-1500/1600 generate a **very high pressure tension** on the front profile and the cover of the awning.

With the **markilux®-1600** this pressure tension is generated by tensioning springs located inside the folding arms.

With the **markilux®-1500** this pressure tension is generated by gas springs, that are attached above the folding arms.

Because of the regulations for the prevention of accidents, these gas springs may not be dismantled, opened (e.g. through pilot drilling), damaged by force or heated above 80°C. The gas springs contain oil and **may only be disposed of through the raw material trade or by a special waste collection point.**

If assembly work becomes necessary on your awning, this may only be performed by a markilux®-specialist!